

Varenummer: 03351008

Beskrivelse: Fluro ledhoved GAXSW 8MS

Mål

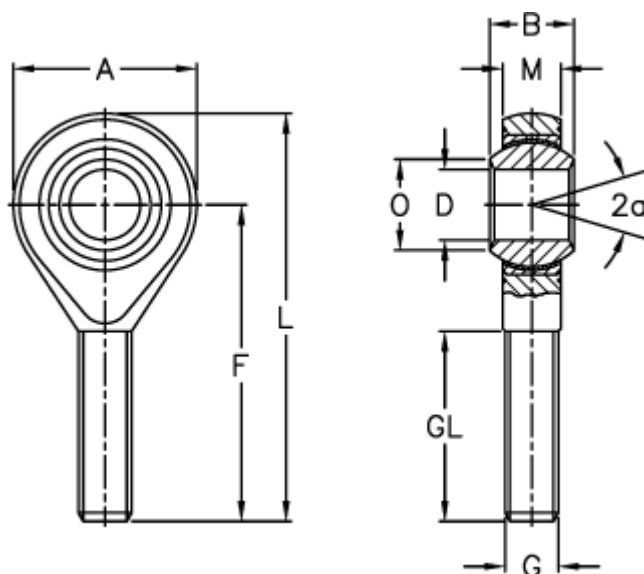

A	= 24	L	= 54
a (grader)	= 14	M	= 9
B	= 12	O	= 10.4
DH7	= 8	Statisk radial belastning C0 (kN)	= 19.5
Dynamisk radial belastning C (kN)	= 19.5	Vægt (g)	= 33
F	= 42		
G	= M8x1,25		
GL	= 25		